



COOK

CIC

DATE: _____
 PROJECT: _____
 LOCATION: _____



**Tubular Centrifugal Inline
 Ceiling Mounted
 Sizes 120-490
 Arrangement 9**

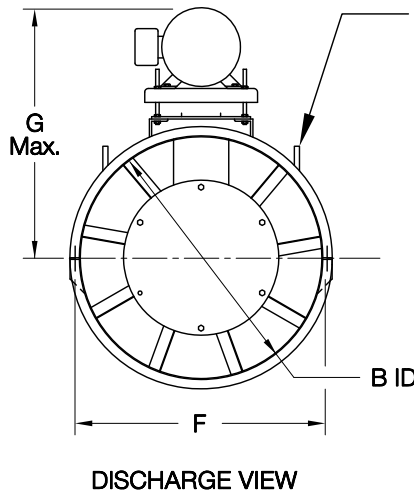
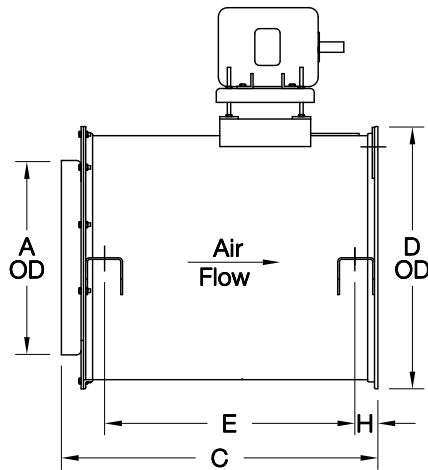

LIFTING LUG LOCATION
 DEPENDS ON THE UNIT
 SIZE AND MOTOR
 POSITION.

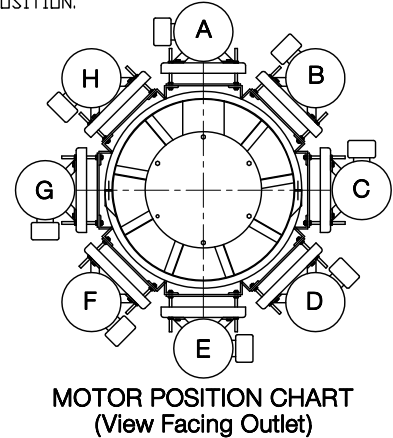

LIFTING LUG LOCATION CHART

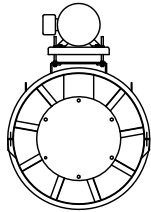

SIZES 120-730
 MOTOR AT POSITION A

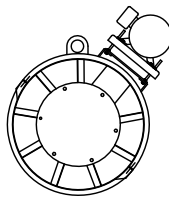

SIZES 120-270 SIZES 300-730
 MOTOR AT POSITIONS B & H

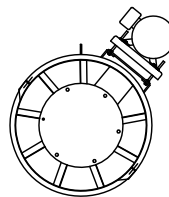

SIZES 120-730
 MOTOR AT POSITIONS C,D,E,F,G

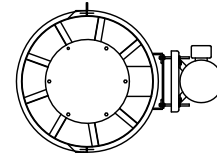

DIMENSION DATA

Size	A	B	C	D	E	F	G*	H	Max. Mtr. Frame	Ship Wt
120	16-1/8	19-1/4	25-3/4	21-3/8	19	20-3/8	20-7/8	2-5/16	184T	195
135	17-5/8	21-9/16	29-1/2	23-3/4	22-3/4	22-3/4	22-7/8	2-5/16	184T	240
150	19-1/8	23-15/16	31-1/4	26-1/8	24-1/2	25-1/8	24	2-5/16	184T	291
165	21-3/16	26-5/16	34	28-1/2	27-1/4	27-1/2	26-3/8	2-5/16	184T	347
180	22-11/16	28-7/16	35-1/4	31-5/8	30-3/8	30-7/8	30	1-3/8	215T	407
195	24-3/16	30-13/16	38	34	33-1/8	33-1/4	32-1/2	1-3/8	215T	472
210	25-15/16	33-1/4	40-13/16	36-7/16	35-15/16	35-11/16	34-1/4	1-3/8	256T	542
225	27-7/16	35-5/8	43-9/16	38-13/16	38-11/16	38-1/16	37	1-3/8	256T	617
245	29-7/16	38-13/16	47-1/4	42	42-3/8	41-1/4	37-3/4	1-3/8	256T	724
270	31-15/16	42-5/16	50	45-1/2	45-1/8	44-3/4	40-3/4	1-3/8	286T	870
300	35	46-9/16	53-1/2	49-3/4	48-5/8	49	43-1/2	1-3/8	286T	1063
330	38	50-11/16	59	53-7/8	54-1/8	53-1/8	46-1/2	1-3/8	324T	1275
365	41-1/2	55-3/4	64-1/4	59-15/16	58-1/2	58-15/16	50	1-13/16	326T	1547
402	45-1/4	61-1/8	67-9/16	65-5/16	61-13/16	64-5/16	54-1/2	1-13/16	364T	1862
445	49-1/2	67-1/8	76-15/16	71-3/8	71-3/16	70-3/8	58	1-13/16	364T	2266
490	55	74-1/8	82-3/16	79-3/8	74-7/16	76-7/8	62	2-13/16	365T	2731

ALL DIMENSIONS IN INCHES. WEIGHTS IN LBS., LESS MOTOR.
 MOTOR POSITION "A" SHOWN.
 *MAY VARY WITH MOTOR FRAME SIZE.
 **SHIPPING WEIGHT BASED ON CLASS I CONSTRUCTION.

CI003R03