

DATE: _____
 PROJECT: _____
 LOCATION: _____

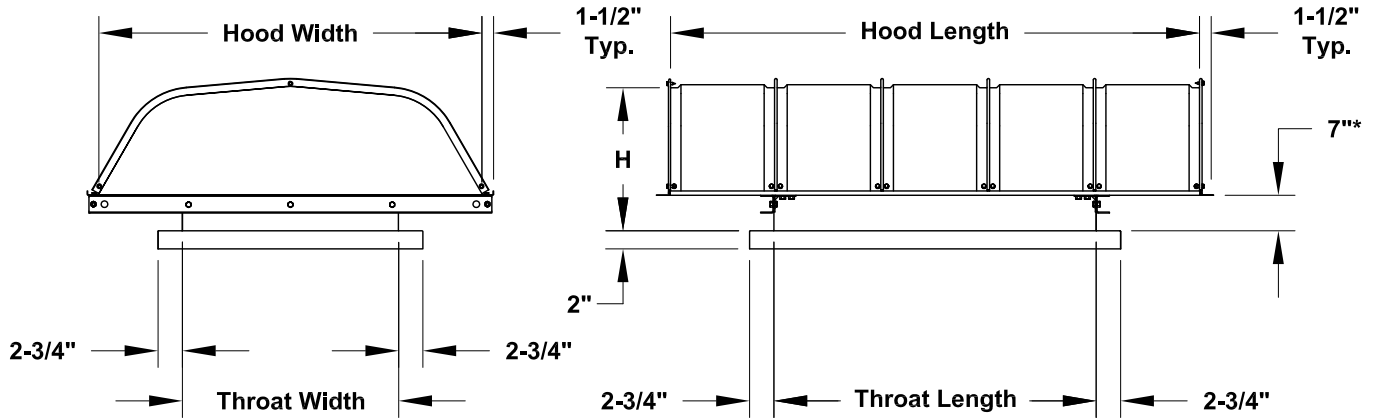

**Aluminum Relief Ventilator
 Hurricane / Missile Impact Resistant**



MIAMI-DADE COUNTY, FLORIDA
 Notice of Acceptance (NOA) Number 13-0708.09/11-13-2018
 -TAS-201: Large Missile Impact Test
 -TAS-202: Uniform Static Air Pressure Test
 -TAS-203: Cyclic Wind Pressure Test

MOTOR INFORMATION

*Note: Units with a throat width 24" or less have a 4" standard throat height.

MAXIMUM THROAT SIZE 36X36

STANDARD CONSTRUCTION FEATURES:

Heavy gauge aluminum construction - Birdscreen
 - Radius throat - Rain gutter - Welded curb cap corners - Integral lifting lugs/tie down points - Hinged hood standard - Five year warranty.

ACCESSORIES

1. GALVANIZED CONSTRUCTION
2. INSECT SCREEN
3. WASHABLE FILTERS
4. GRAVITY BACKDRAFT DAMPER
5. MOTORIZED BACKDRAFT DAMPER
6. RCG GALVANIZED ROOF CURB
7. RCA ALUMINUM ROOF CURB
8. LORENIZED FAN FINISH
9. EPOXY COATING
10. ALUMINUM BIRDSCREEN
11. ANTI-CONDENSATE COATING

DESIGN PRESSURE:

- ±130PSF - Galvanized Steel Construction
- ±60PSF - Aluminum Construction

QTY	MARK	THROAT SIZE	HOOD SIZE	HEIGHT	CFM	THROAT VELOCITY	PRESSURE DROP	ACCESSORIES		
		L X W	L X W	H						